

RSR/VT A&D “ANDY” Board

**User Manual
and
Test Procedure**

Version 2.2

June 5, 2006

Copyright © 2005-2006

By R. B. Lineberry, W. C. Headley, and R. W. Hendricks

The Bradley Department of Electrical and Computer Engineering
Virginia Tech
Blacksburg, Virginia 24061

General Operating Instructions

- 1) Read this manual in its entirety before engaging in any experimentation.
- 2) The A&D (ANDY) board should be tested upon receipt to assure that all sections of the board operate within specifications. See the Test Procedure section.
- 3) Never construct a circuit or insert any wiring with power applied to the board.
- 4) Construct the circuit per your laboratory manual and then double check the wiring.
- 5) Should a problem occur, unplug the power cord from the board immediately and look for obvious errors.
- 6) If you have a disaster, follow the instructions for technical support, which should be in your syllabus or course web site.

Description

The objective of the ANDY board is to provide the student with an easy to use, mobile, and multipurpose learning tool that can be used to develop many aspects of circuit design and analysis. The ANDY board is designed to support a rich, hands-on experience in digital logic, DC circuit analysis, and AC circuit analysis through the use of take home labs and design projects. The board provides plenty of breadboard space for students who may need to do more than one lab concurrently for different courses. Because of its small size and power supply, the board is mobile, providing the student with the opportunity to work on experiments wherever she or he feels comfortable. The ANDY board provides a more relaxed environment to learn material, which leads to better comprehension.

Specifications

Power Supplies

- +5 volts DC @ 0.5 Amps (including current drawn from +9 volts)
- +9 volts DC @ 0.5 Amps (including current drawn from +5 volts)
- -9 volts DC @ 0.5 Amps

Ground

- A common ground is used throughout the board.
- Connect your circuit to the closest GND socket header.

Two Standard Breadboards

- 4 bus lines on each breadboard, each containing 50 sockets
- 2 sets of 63 nodes containing 5 sockets each
- Chip channel running through the middle of each board between each set of nodes

Function Generator

- Sine or square wave output, switch selectable
- Sine wave output adjustable up to 10 volts peak-to-peak into a 1K load
- Square wave output adjustable up to 13 volts peak-to-peak into a 1K load
- Sine or square wave output approximately 2.5 volts peak-to-peak into a 50 ohm load
- Frequency range variable from approximately 60 Hz to 20 KHz
- Adjustable DC offset if selected by switch

A&D Board User Manual and Test Procedure

Digital Clock

- +0.3 to +4.7 volt (typical) square wave generator
- Frequency range variable from approximately 60 Hz to 40 KHz

Digital Pulsers

- 2 debounced momentary push buttons
- Compatible with 74HC logic
- Complimentary outputs (high-true and low-true)

Digital Switches

- 16 buffered switches
- Compatible with 74HC logic

Digital Logic Probes

- 16 logic indicators distinguish high state, low state, and indeterminate state
- Compatible with 74HC logic
- Display disable switch

Wiring

- Breadboards and socket headers are compatible with 22 gauge solid wire
- Strip 5/16 (8 mm) of insulation to insure a good connection
- Larger wire or component leads may permanently damage connectors

Bi-Polar LED

- A red and a green light-emitting diode in a single package
- Used in both the digital and analog sections of the board
- Red indicates a high logic state or positive analog voltage
- Green indicates a low logic state or negative analog voltage

Operation

The circuit diagram of the ANDY board is shown in Appendix A. The silk screen of the board is shown in Figure 1. The six different sections of the board that are used to connect to the breadboard are outlined in red: the power sources; the digital logic probes; the digital switches; the digital pulsers; the digital clock; and the function generator. Each section has labeled socket headers associated with it. Socket headers are the black boxes surrounding the breadboards into which wires can be inserted.

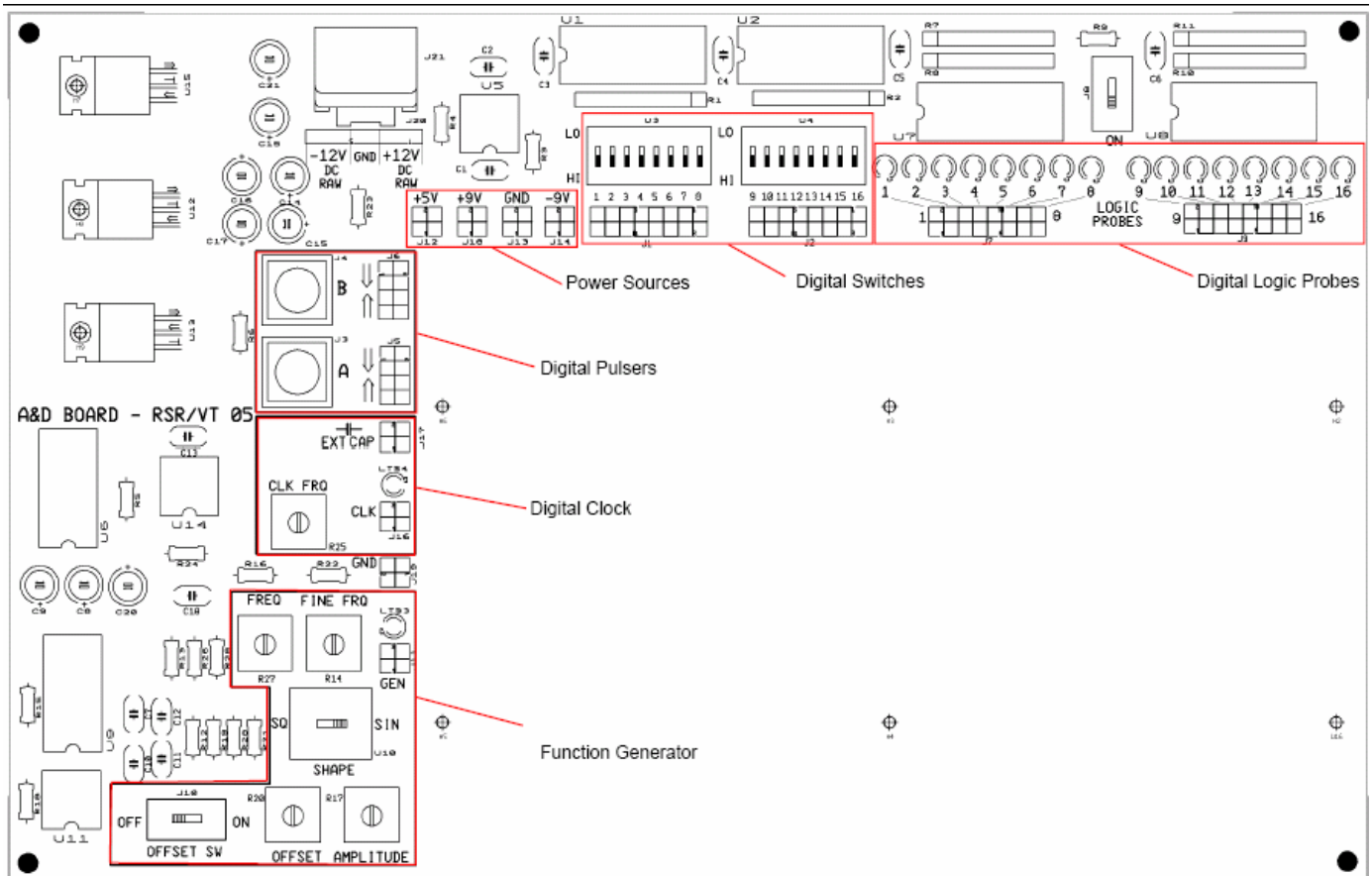

Figure 1: Silk screen layout of the RSR/VT A&D (ANDY) board

The function and operation of each section of the board is discussed in the following paragraphs:

A) Power Sources

These socket headers are labeled “+5V”, “+9V”, and “-9V”. Any of the 4 holes on a socket header may be used to connect a power source to a circuit on the breadboard.

The ANDY board contains two common ground socket headers: one between the +9V and -9V socket headers and another between the clock and the function generator socket headers. The common ground will be used as the reference node for the circuits designed on the breadboard.

A&D Board User Manual and Test Procedure

It is common practice to connect each power source to a breadboard bus. The busses are labeled with a red line to represent the '+' busses and a blue line to represent the '-' busses. These busses provide a convenient and effective method to distribute power to your circuit

For advanced users, the raw power supplied to the board by the wall adapter is available in the socket headers labeled "+12V Raw" and "-12V Raw".

B) Digital Logic Probes

The 16 logic probes are compatible with the 74HC logic family. The slide switch disables the LED indicators, when desired.

There are 2 logic probe socket headers, labeled 1-8 and 9-16. Each header has two rows of 8 columns, to indicate 2 functionally identical sockets for each signal input. Each column has a white line between a header column and a bi-polar LED as a visual aid.

Each logic probe input connects to a circuit, which compares logic levels 60 times a second. When the logic probe switch is ON, a bi-polar LED displays the output of this comparison circuit.

When an input is at a HIGH (or 1) logic state, the corresponding LED will light RED. When an input is at a LOW (or 0) logic state, the corresponding LED will light GREEN. If the input is changing state, the LED color will fluctuate in concert.

When an input is not connected to an external circuit, it can be affected by very low input currents, and the LED-s may flicker. This indicates an indeterminate logic state. For fun, run your finger along the top of the socket headers.

C) Digital Switches

The 16 digital switch outputs are buffered and compatible with the 74HC logic family.

There are two digital switch socket headers, labeled 1-8 and 9-16. Each header has two rows of 8 columns, to indicate 2 functionally identical sockets for each output signal. Each column has a number between a socket and its corresponding switch.

There are two "dual inline package" (DIP) switches, labeled 1-8 and 9-16. Each switch is labeled LO (= ON) and HI (= OFF). When a switch is in the LO position, the corresponding socket will output a logic LOW (or 0). When a switch is in the HI position, the corresponding socket will output a logic HIGH (or 1).

CAUTION: Do not use a pencil to change the switch positions. Pencil "lead" is conductive and will destroy your switch. A retracted ballpoint pen works well.

D) Digital Pulsers

There are two digital pulsers, with identical functionality, labeled "A" and "B". These pulsers are compatible with the 74HC logic family. Each pulser output connects to a 4 row by 2 column socket header.

The top two rows, of each socket header, are labeled with a "down arrow" and the bottom two rows are labeled with a "up arrow". This gives you 4 possible connections to either function.

The "down arrow" indicates that pushing the momentary push button will cause the output to change to a LOW (or 0) state, *only* while the button is pushed. When the push button is released, the output returns to a HIGH (or 1) state. The pulser is de-bounced, so there is only one logic transition pulse per button push.

The "up arrow" pulser starts at logic LOW (or 0) and becomes HIGH (or 1) only when the button is pushed.

E) Digital Clock

The digital clock provides a square wave output with approximately 50% duty cycle. Its frequency can be varied between about 60 Hz and 40 kHz, using the CLK FRQ knob. The clock frequency increases when the knob is turned clockwise. The high state is typically 4.7V and the low state is typically 0.3V. Any of the 4 holes of the CLK socket header may be used to connect the digital clock to a circuit on the breadboard.

A bi-polar LED, located between the CLK and EXT CAP socket headers, indicates the logic state. When this LED lights both red and green, the digital clock is operating normally. If the output is stuck low, the LED will be green; when stuck high, the LED will be red.

The frequency range of the digital clock may be lowered by adding an external capacitor to the EXT CAP socket header. Orient the external capacitor as illustrated by the symbol just to the left of the header. You may use the top row, bottom row or both rows (for 2 external capacitors in parallel).

F) Function Generator

The function generator outputs sine or square waveforms with adjustable frequency, amplitude, and offset. The frequency can be adjusted from approximately 60 Hz to 20 kHz. The amplitude can be as high as ± 7 volts, depending on the load impedance. The offset control can be used to compensate for component and circuit variations.

Any of the 4 holes of the GEN socket header may be used to connect the function generator to a circuit on the breadboard.

To select a square wave output, set the SHAPE switch to SQ. To select a sine wave output, set the SHAPE switch to SIN.

The AMPLITUDE control adjusts the output voltage of the function generator. A clockwise rotation increases the output voltage.

If the FINE FRQ control is turned fully counter-clockwise, the FREQ control adjusts the output frequency between approximately 60 Hz and 5 kHz. A clockwise rotation increases the frequency.

If the FREQ control is adjusted fully clockwise, the FINE FRQ control adjusts the output between approximately 5 kHz and 20 kHz. If the FREQ control is set mid-range, the FINE FRQ control can be used to make small adjustments to the output frequency.

The function generator has a small, non-linear DC offset, which is dependent on wave shape, frequency, and amplitude. If the driven circuit is not sensitive to these variations, the OFFSET SW can be set to OFF.

When the OFFSET SW is set to ON, the OFFSET control injects a DC bias. Turn the control clockwise for a positive bias. This function is normally used to equalize the waveform transitions above and below ground.

The bi-polar LED, just above the GEN header, indicates the relative output of the function generator. When the OFFSET SW is ON, and the AMPLITUDE control is fully clockwise, the OFFSET control can be rotated clockwise to produce a red-lit LED, or counter-clockwise to produce green.

Test Procedure

The test procedure for the ANDY board is found in Appendix B. This procedure should be followed when first receiving the board to determine if the board is functioning according to specifications. When a problem arises, the test procedure can be used to narrow the scope of the problem.

User Repairs

The user should *not* attempt to repair the ANDY board, without explicit instructions from your course instructor or technical support team. Doing so could void your warranty.

Technical Support

Follow the instructions on the class web site for technical assistance and warranty service.

Warranty

The ANDY board is warranted for three years from the date of original purchase. User abuse, as determined by the technical support team or the manufacturer, may void the warranty.

Appendix A: A&D Board Circuit Diagram.

(see next page)

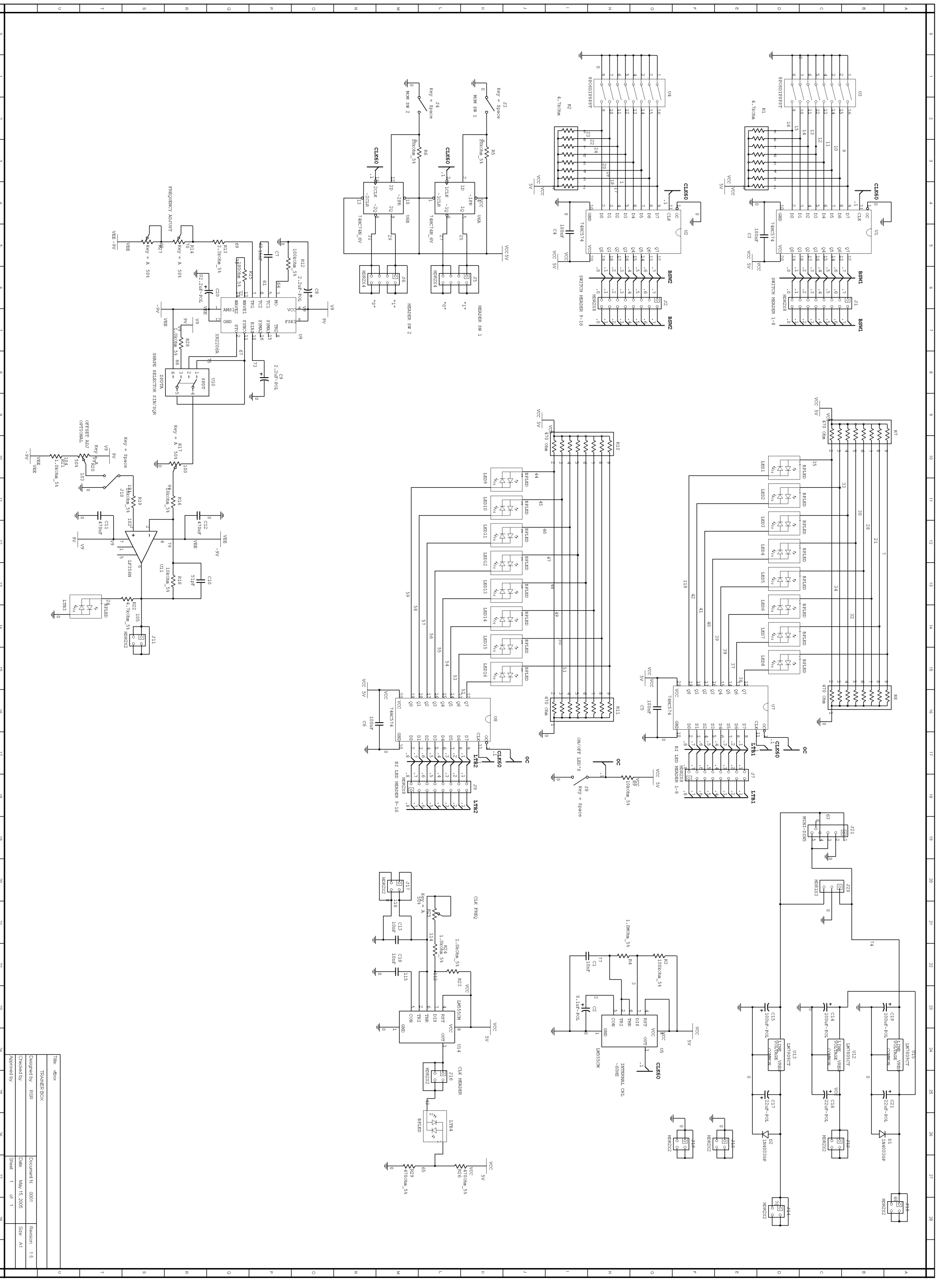

Title	tb04
TRAINER BOX	
Designed by	RSR
Checked by	
Approved by	
Document N.	0001
Date	May 15, 2005
Size	A1
Sheet	1 of 1
Revision	15

Appendix B: A&D Board Test Procedure

Use this check sheet to perform an initial verification of the A&D board. Place a check mark in the box to the left of each item as it is completed.

Name: _____ Student No: _____

Required Equipment

- A&D Board, with Power Supply Module
- Tektronix TDS210 oscilloscope.¹
- A BNC-to-mini-grabber test lead, available in the Computer Engineering Labs.
- A 10k Ω resistor (1/2 watt, 5%), available in the Computer Engineering Labs.

Initial Inspection

1. [] Work on a clean, non-conductive surface. Inspect the A&D Board for damaged components. Check that the integrated circuit chips are seated tightly in their sockets. Refer to Figure 1 for component layout.
2. [] Inspect the Power Supply Module for damage. Inspect the 5-pin circular DIN connector (DIN5) for bent shell or pins. Inspect the power cable for damaged insulation or strain relief.

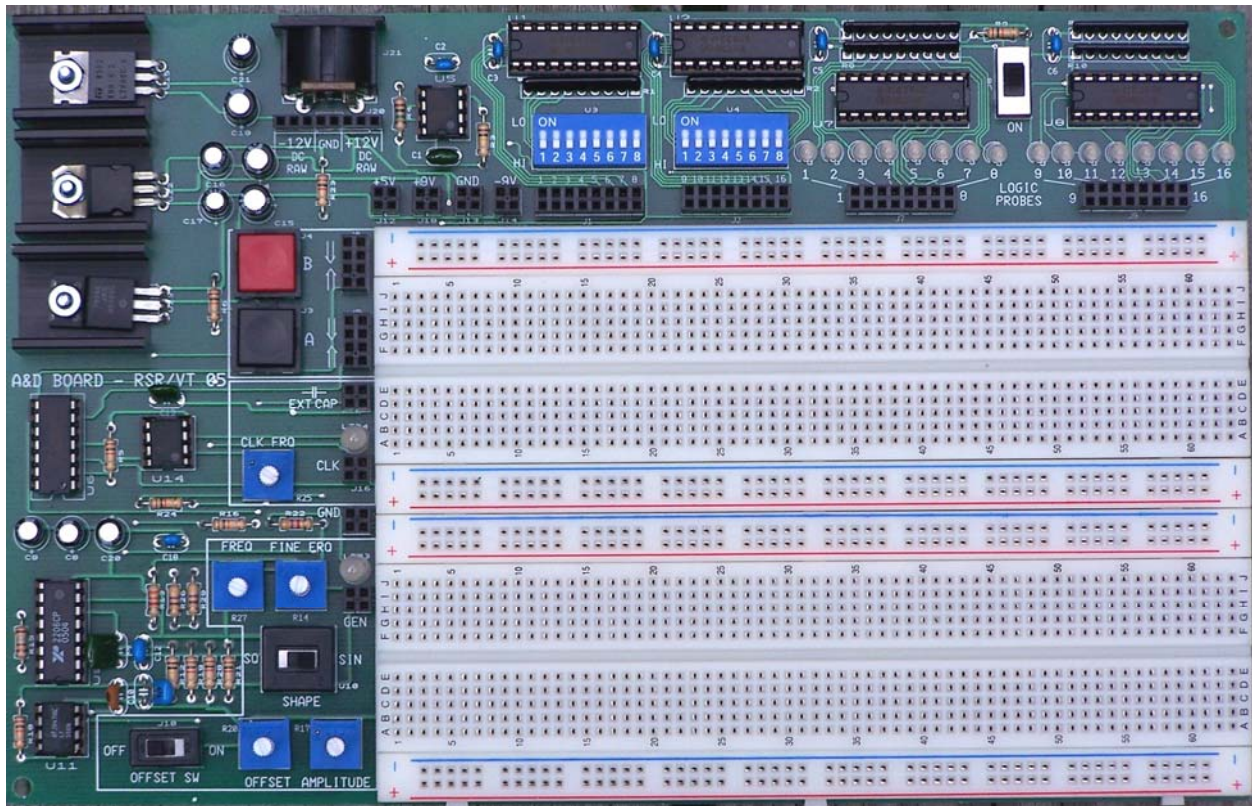

Figure 1: A&D Board

¹ You may use an oscilloscope in the Computer Engineering Labs (CEL). See <http://www.ece.vt.edu/cel/> for location and hours of operation

Oscilloscope Operation²

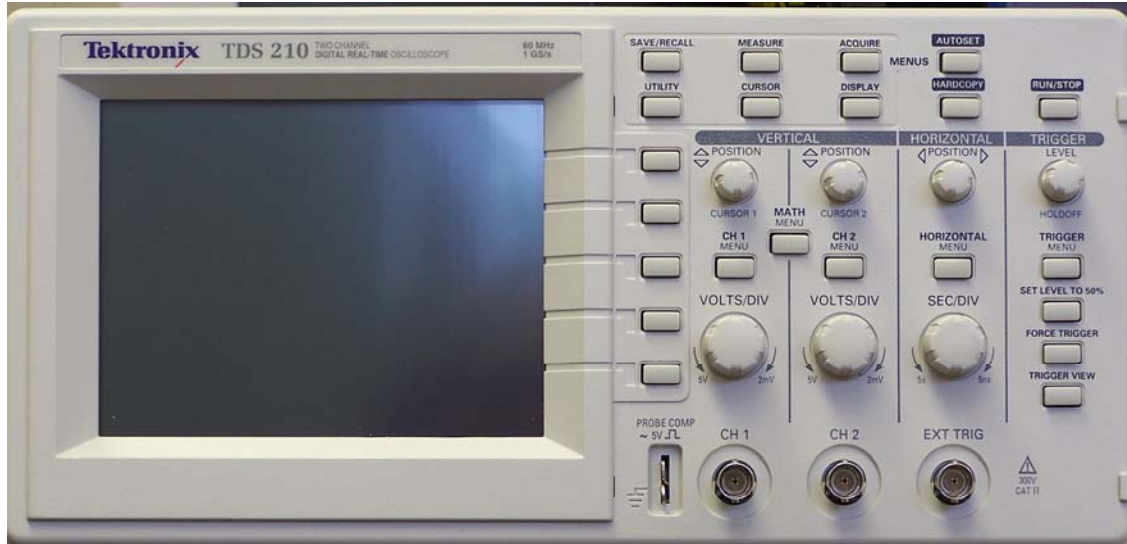

Figure 2: TDS210 Oscilloscope Front Panel

1. [] Turn on the TDS210 oscilloscope. The power button is top left.
2. [] Connect a BNC-to-mini-grabber cable to the CH 1 BNC connector of the TDS210 oscilloscope.
3. [] Connect the red mini-grabber end to the TDS210 PROBE COMP ~ 5V \square (upper connector).
4. [] Press the CH 2 Menu button until the CH 2 indicators disappear from the bottom of the screen.
5. [] Press the CH 1 Menu button until the CH 1 waveform appears on the TDS210 screen.
6. [] Use the buttons just to the right of the TDS210 screen to set CH 1: Coupling=DC, BW Limit=OFF, Volts/Div=Coarse, Probe=1X, Invert =OFF.
7. [] Press AUTOSET
8. [] Verify the waveform looks very similar to Figure 3.

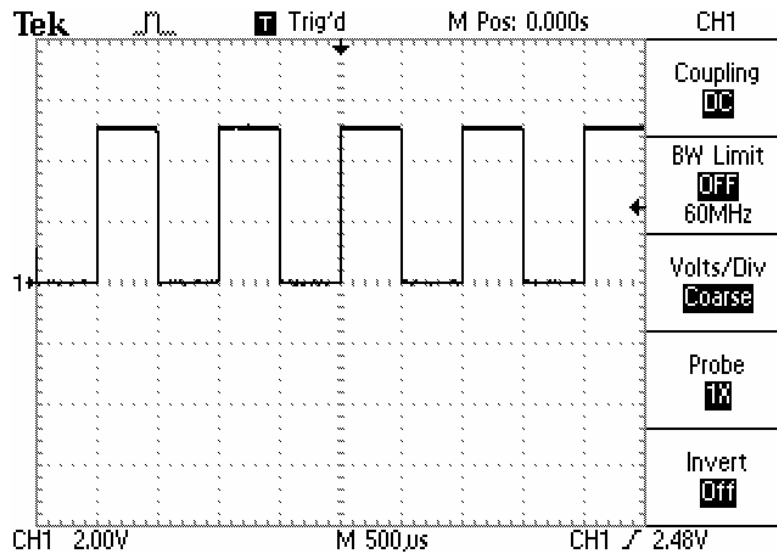

Figure 3: Oscilloscope Display of Probe Comp ~ 5V \square

² The TDS210 Oscilloscope manual can be found at <http://www.ece.vt.edu/cel/help/TDS210-User-Manual.pdf>

Power Supply Operation

1. [] Disconnect the red mini-grabber from TDS210 PROBE COMP ~ 5V □□.
2. [] Gently rotate the DIN5 connector of the power supply module to find the correct orientation and plug it into the A&D board.
3. [] Plug the power supply module into a 120V AC outlet.
4. [] Set the Logic Probes switch to “ON”. Notice the Logic Probe LEDs are lit and possibly blinking.
5. [] Press the TDS210 MEASURE button.
6. [] Press TDS210 Source/Type to highlight Source.
7. [] Press the button below Source/Type to choose CH1 for that field.
8. [] Press the next button down to choose CH1. Thus, at least two fields are labeled CH1.
9. [] Press Source/Type to highlight Type.
10. [] Press the button below Source/Type to choose CH1/Mean for that field.
11. [] Press the next button down to choose CH1/Pk-Pk for the other field. See Figure 5.
12. [] Select a 10 K ohm resistor from your parts kit or CEL parts supply. Bend both leads at a right angle. Insert one end into the A&D Board +5V socket connector and the other end into the GND socket connector.
13. [] Connect the black mini-grabber to the end of the 10kΩ resistor connected to GND. See Figure 4. *Note: When measuring a signal, always connect the black mini-grabber to ground.*

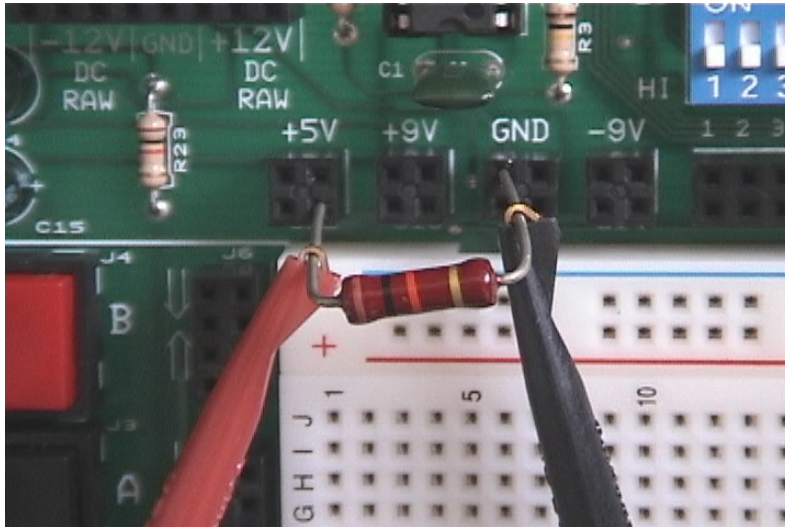

Figure 4: Connecting Mini-grabbers to Socket Connectors

14. [] Connect the red mini-grabber to the end of the 10kΩ resistor connected to +5V. See Figure 4.

A&D Board User Manual and Test Procedure

15. The oscilloscope should display a straight horizontal line at about 5V. See Figure 5.

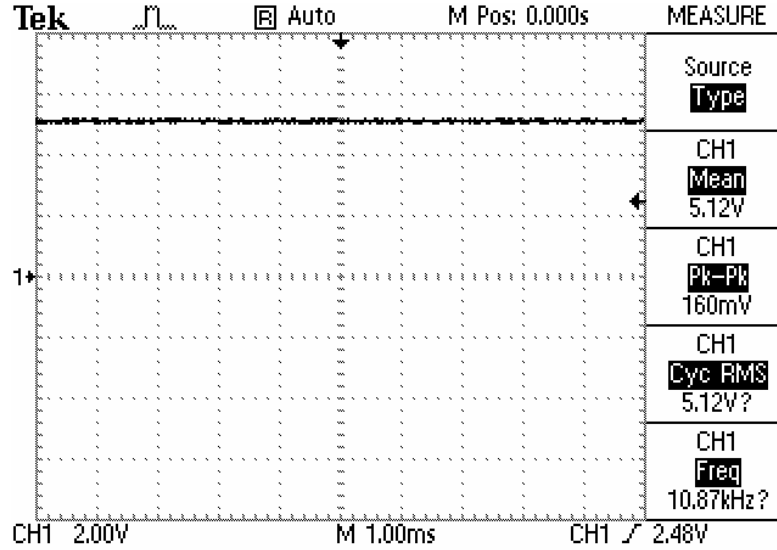

Figure 5: Oscilloscope Display of +5V Power Supply

16. Verify that the Mean voltage is $5V \pm 5\%$.
17. Verify that the Pk-Pk voltage is around 300 mV or less.
18. Remove the red and black mini-grabbers from the 10k Ω resistor.
19. Connect the 10k Ω resistor between +9V and GND.
20. Turn the TDS210 CH1 VOLTS/DIV knob counter-clockwise to indicate 5.00 V/division.
21. Connect the scope probe mini-grabbers across the 10k Ω resistor, black to GND.
22. The oscilloscope waveform should be a straight horizontal line at about +9V. See Figure 6.

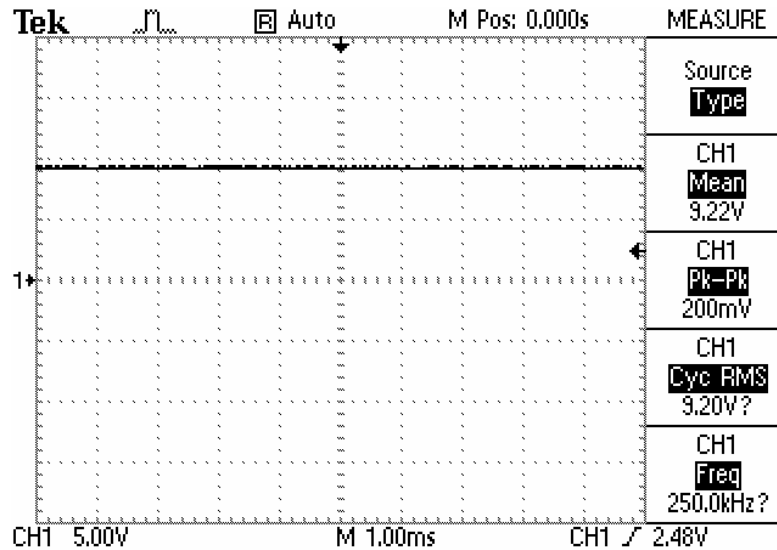

Figure 6: Oscilloscope Display of +9V Power Supply

23. Verify that the Mean voltage is $+9V \pm 5\%$.
24. Verify that the Pk-Pk voltage is around 400 mV or less.
25. Remove the red and black mini-grabbers from the 10k Ω resistor.
26. Connect the 10k Ω resistor between -9V (minus 9V) and GND.

A&D Board User Manual and Test Procedure

27. [] Connect the scope probe mini-grabbers across the 10k Ω resistor, black to GND.
28. [] The oscilloscope waveform should be a straight horizontal line at about -9V. See Figure 7.

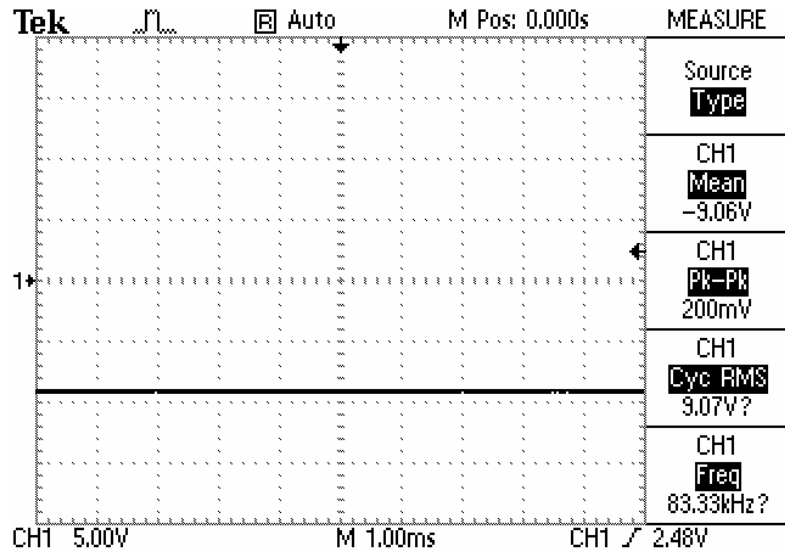

Figure 7: Oscilloscope Display of -9V Power Supply

29. [] Verify that the Mean voltage is -9V \pm five percent.
30. [] Verify that the Pk-Pk voltage is around 400 mV or less.

Digital Clock

1. [] Remove the red and black mini-grabbers from the 10kΩ resistor.
2. [] Turn the TDS210 CH1 VOLTS/DIV knob one click clockwise to indicate 2.00 V/division.
3. [] Connect a 10kΩ resistor between the A&D Board CLK and GND socket connectors.
4. [] Connect the scope probe mini-grabbers across the 10kΩ resistor, black to GND.
5. [] Note that the LED, next to the CLK socket connector, glows green and red. This indicates that the digital clock circuit is oscillating.
6. [] Turn the A&D Board CLK FRQ (clock frequency) knob fully counter-clockwise.
7. [] Press the TDS210 AUTOSET button. The waveform that appears should look like Figure 8.

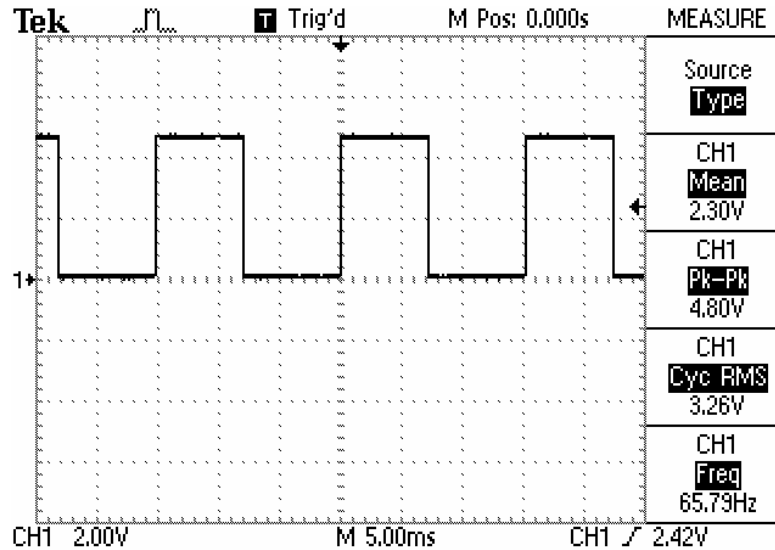

Figure 8: Oscilloscope Display of 60 Hz Digital Clock

8. [] Press TDS210 Source/Type to highlight Source.
9. [] Press each button, below Source/Type to choose CH1 for each field.
10. [] Press Source/Type to highlight Type.
11. [] The first two fields are already set to “Mean” and “Pk-Pk”. Set the remaining two fields to “Cyc RMS” and “Freq”.
12. [] Verify that the Digital Clock is producing a square wave, with about 5V Pk-Pk and 60 Hz Frequency. The waveform should rise and fall quickly, with flat tops and bottoms.
13. [] Slowly turn the A&D Board CLK FRQ knob clockwise. As the frequency increases, more cycles are shown on the TDS210 display.
14. [] Continue increasing the Digital Clock frequency, until the TDS210 display becomes a black rectangle.

15. [] Turn the TDS210 SEC/DIV knob clockwise, to display approximately 4 waveforms. See Figure 9.

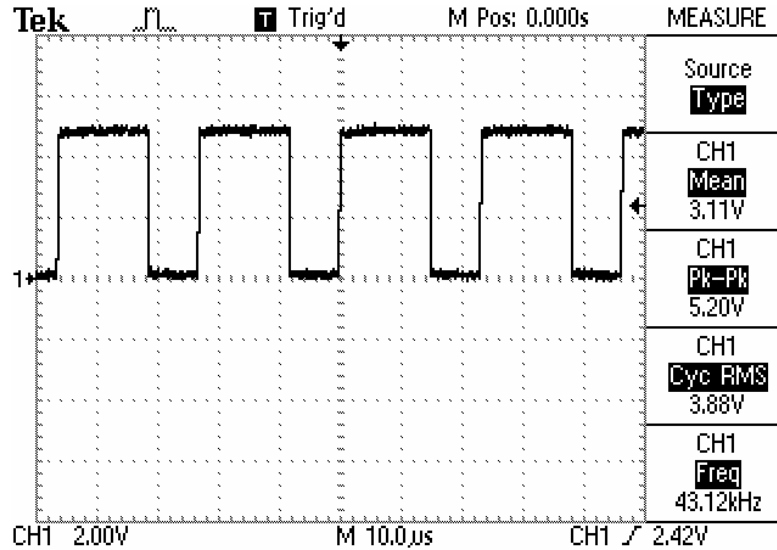

Figure 9: Oscilloscope Display of 40 kHz Digital Clock

16. [] Verify that the Digital Clock is producing a square wave, with about 5V Pk-Pk and 40 kHz Frequency. The waveform should rise and fall quickly. The tops and bottoms may have some ringing, undershoot, and noise, which is normal.

Sine/Square Wave Function Generator

1. [] Remove the red and black mini-grabbers from the 10kΩ resistor.
2. [] Connect a 10kΩ resistor between A&D Board GEN and GND socket connectors.
3. [] Connect the scope probe mini-grabbers across the 10kΩ resistor, black to GND.
4. [] Turn the A&D FREQ and FINE FRQ knobs fully counter-clockwise.
5. [] Set the A&D OFFSET and AMPLITUDE knobs to mid-position.
6. [] Set the A&D SHAPE toggle to “SIN” for Sine Wave output.
7. [] Set the A&D OFFSET SW to “OFF”.
8. [] Press AUTASET.
9. [] Turn the TDS210 CH1 VOLTS/DIV knob counter-clockwise to indicate 2.00 V/division.

10. [] Gradually turn the A&D AMPLITUDE knob clockwise and verify that the amplitude increases up to approximately 10V Pk-Pk at 60 Hz as shown in Figure 10.

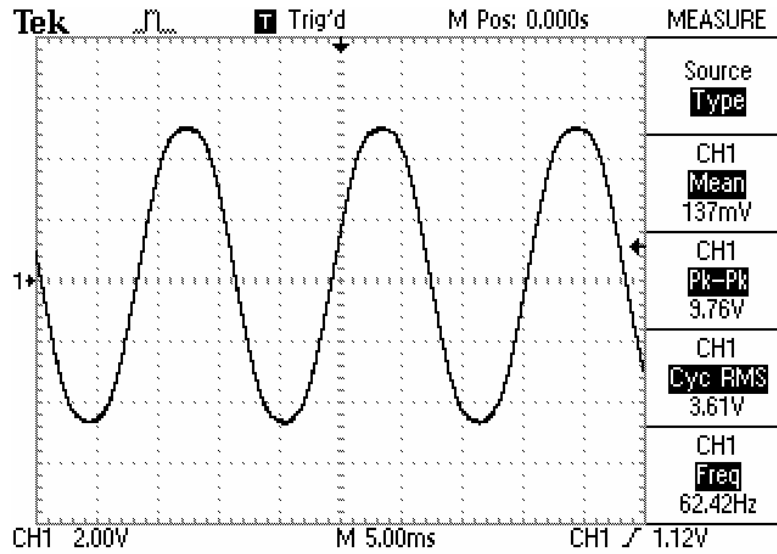

Figure 10: Oscilloscope Display of 60 Hz Sine Wave

11. [] Turn the TDS210 SEC/DIV knob clockwise to indicate 100us/division.
 12. [] Gradually turn the A&D FREQ (60 Hz to 5 kHz) knob clockwise and verify that the frequency increases up to approximately 5 kHz at 10V Pk-Pk as shown in Figure 11.

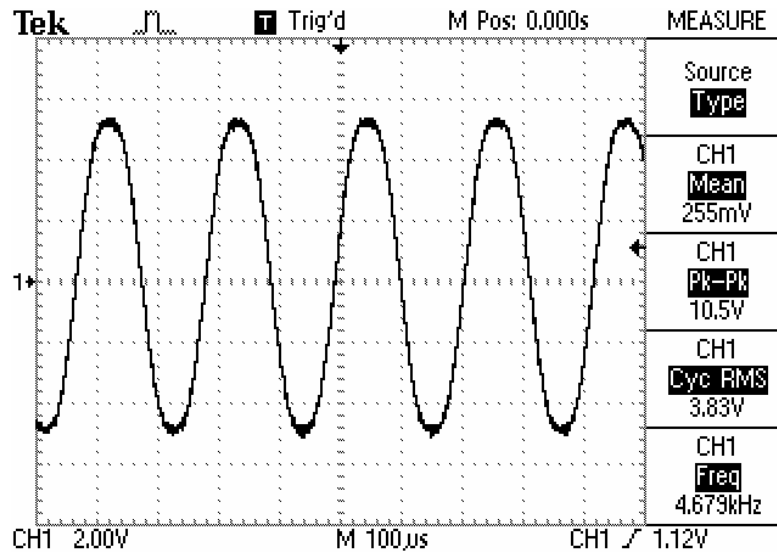

Figure 11: Oscilloscope Display of 5 kHz Sine Wave

A&D Board User Manual and Test Procedure

13. [] Turn the TDS210 SEC/DIV knob clockwise to indicate 10us/division.
14. [] Gradually turn the A&D FINE FRQ (5 kHz to 20 kHz) knob clockwise and verify that the frequency increases up to approximately 20 kHz at 10V Pk-Pk as shown in Figure 12.

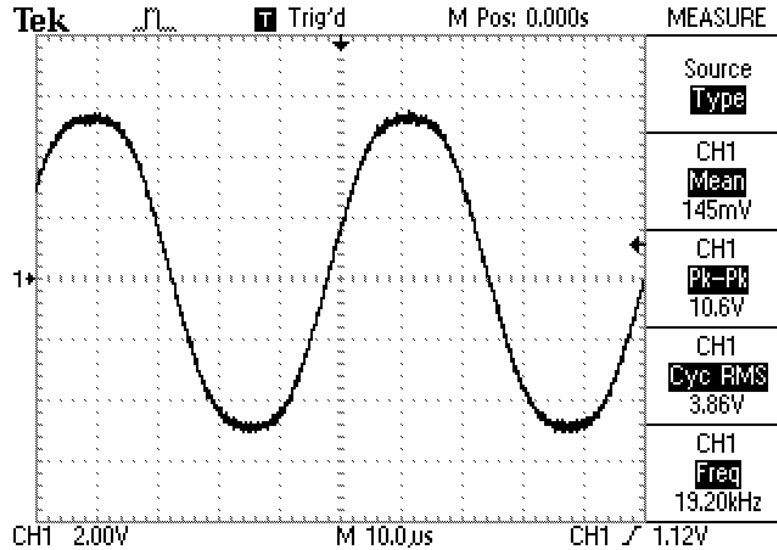

Figure 12: Oscilloscope Display of 20 kHz Sine Wave

15. [] Keeping the A&D AMPLITUDE knob turned fully clockwise, set the A&D OFFSET SW to “ON”.
16. [] Gradually rotate the A&D OFFSET knob in both directions. Notice that the waveform becomes flat on the top or bottom, as the function generator output approaches the power supply limits. The OFFSET control can be used to compensate for component variations.
17. [] Set the A&D OFFSET SW to “OFF”.
18. [] Set the A&D SHAPE toggle to “SQ” for Square Wave output.
19. [] Verify that the output is a square wave of approximately 20 kHz at approximately 13V Pk-Pk as shown in Figure 13.

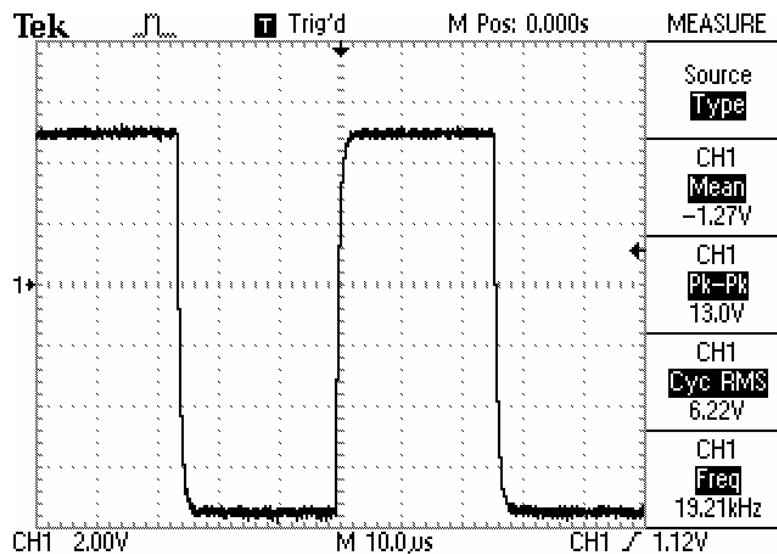

Figure 13: Oscilloscope Display of 20 kHz Square Wave

20. [] Turn the TDS210 SEC/DIV knob counter-clockwise to indicate 50us/division.

A&D Board User Manual and Test Procedure

21. [] Minimize the A&D FINE FRQ control. Verify an output of approximately 5 kHz at 13V Pk-Pk as shown in Figure 14.

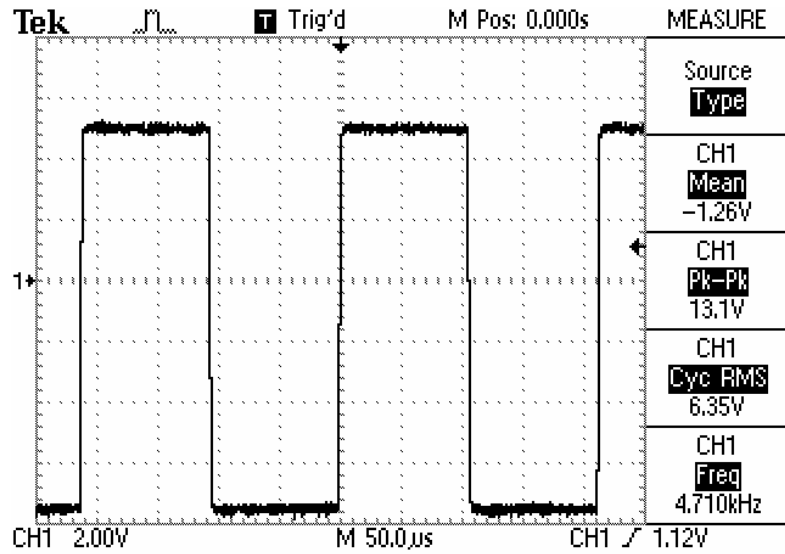

Figure 14: Oscilloscope Display of 5 kHz Square Wave

22. [] Turn the TDS210 SEC/DIV knob counter-clockwise to indicate 5ms/division.
23. [] Minimize the A&D FREQ control. Verify an output of approximately 60 Hz at 13V Pk-Pk as shown in Figure 15.

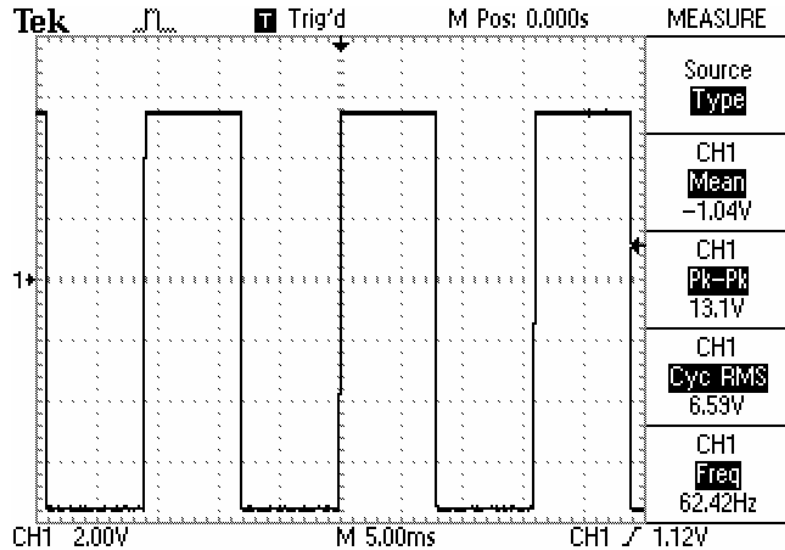

Figure 15: Oscilloscope Display of 60 Hz Square Wave

A&D Board User Manual and Test Procedure

24. [] While watching the TDS210 CH1 Pk-Pk display, adjust the A&D AMPLITUDE knob to obtain approximately 1V Pk-Pk (Hint: adjust TDS210 CH1 VOLTS/DIV as needed). While watching the TDS210 CH1 Freq display, adjust the FREQ knob to obtain a 1 kHz square wave (Hint: adjust TDS210 SEC/DIV as needed). See Figure 16.

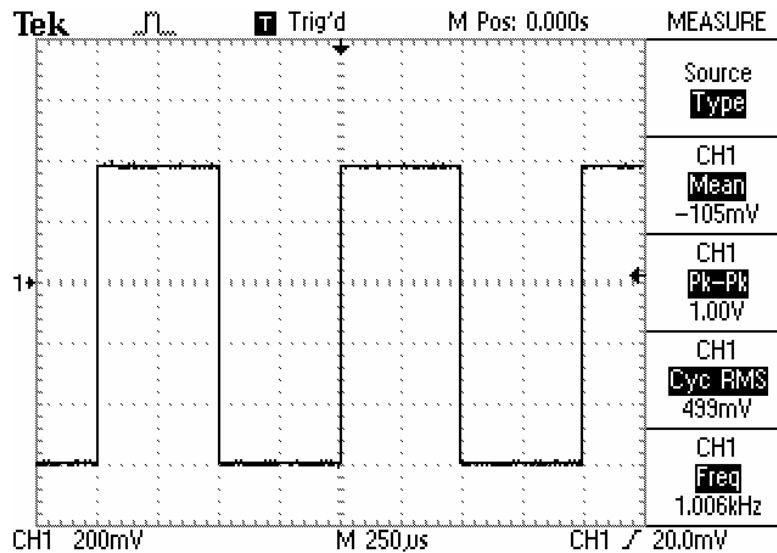

Figure 16: Oscilloscope Display of 1 kHz Square Wave

25. [] Set the A&D SHAPE toggle to “SIN” for Sine Wave output.
26. [] Use the A&D AMPLITUDE knob and FREQ knob to obtain a 1 kHz sine wave at 1V Pk-Pk. Did you need to adjust the A&D FREQ knob? See Figure 17.

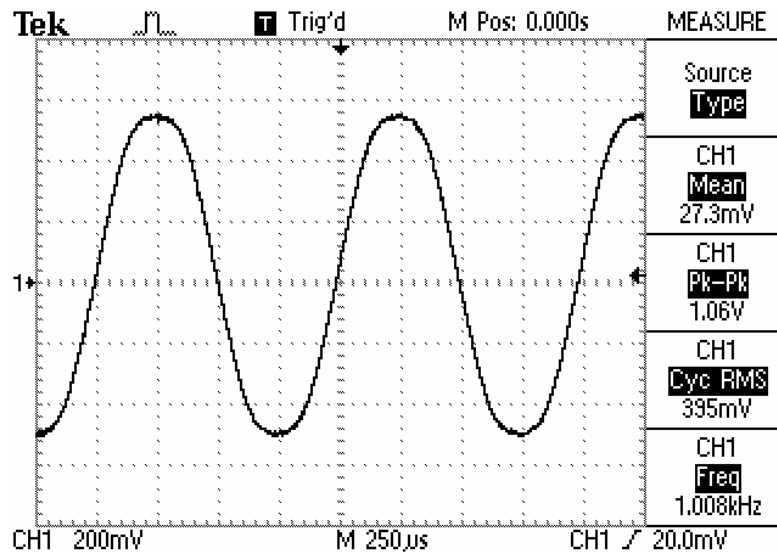

Figure 17: Oscilloscope Display of 1 kHz Sine Wave

27. [] Disconnect the mini-grabbers from the A&D board and turn off the oscilloscope. Return the scope probe to the wall rack in the CEL. Remove the 10kΩ resistor from the A&D board.

Logic Probes

1. [] Set the LOGIC PROBE switch to ON.
2. [] Make sure all Logic Probe LEDs are lit. *Note: When a logic indicator has no input it is in an indeterminate state and the color of its LED could be red, green, or flickering.* For fun, run your finger over the tops of the Logic Probe inputs.
3. [] Connect a wire between the +5V socket connector and logic probe 1 (LP1). The LP1 LED should be lit red indicating a logic HI or '1'. Ignore the color of LEDs LP2 – LP16 as they are in an indeterminate state.
4. [] Repeat step 3 for each of the other logic probes (LP2 – LP16).
5. [] Move the wire to connect GND to LP1. The LED should be lit green indicating logic low or '0'. Again ignore the other LEDs.
6. [] Repeat step 5 for each of the logic probes (LP2 – LP16).

Logic Switches³

1. [] Set all of the switches to the HI (or OFF) position.
2. [] Connect a wire between switch 1 (S1) and LP1. The LED should be lit red.
3. [] Set the switch to the LO position. The LED should be lit green.
4. [] Read footnote 3. Toggle the switch to be sure the LED changes between red (HI) and green (LO).
5. [] Repeat steps 2-4 for the remaining 15 switches (S2 – S16).

Pulsers

1. [] Connect a wire between any socket in the top two rows (represented by the down arrow) of Pulser A (PA) and LP1. The LED should be lit red.
2. [] Press down on PA. The LED should go from red (HI) to green (LO).
3. [] Move the wire to connect any socket in the bottom two rows (represented by the up arrow) of PA and LP1. The LED should be lit green.
4. [] Press down on PA. The LED should go from green (LO) to red (HI).
5. [] Repeat steps 1-4 for Pulser B (PB).

³ (Note: Do not use a graphite pencil to move switches as graphite flakes may enter the switch with continued use and thus short the switch. A PDA stylus or a mechanical pencil with the lead retracted is acceptable.)

A&D Board User Manual and Test Procedure

Completion

1. [] Unplug the power supply module from the 120V AC outlet and then the DIN5 connector from the breadboard.
2. [] Write a detailed description of any test that does not meet specifications in the comment block below.
3. [] If you had difficulty with any of the test procedures, or discovered errors, please comment below and communicate this information to your instructor.
4. [] For help with A&D Board service, follow the instructions on the CEL web page for your class.

Comments:

I have performed the above procedure and, excluding the exceptions noted above, I am satisfied the A&D board is working properly.

Signature: _____

Date: _____